

**TARA ULTRA Mitigeur monocommande Pour douchette extractible/pendulaire -
Champagne brossé (Or 22cts)**











TARA ULTRA

33 826 875



- saillie 241 mm
- bec pivotant 360°
- jet enrichi en air
- hauteur de robinetterie 393 mm
- hauteur jusqu'au mousseur 240 mm
- diamètre de percement mitigeur monocommande 35 mm
- débit d'eau maxi. 8 l/min avec une pression d'écoulement de 3 bars
- sans plomb
- Ce produit contribue au respect des exigences des systèmes d'évaluation des bâtiments écologiques, par exemple LEED®, BREEAM®, DGNB

Mitigeur monocommande à combiner uniquement avec une douchette extractible/pendulaire

	Champagne brossé (Or 22cts)	33 826 875-46
	Chrome	33 826 875-00
	Platine brossé	33 826 875-06
	Platine	33 826 875-08
	Laiton (Or 23cts)	33 826 875-09
	Dark Chrome	33 826 875-19
	Laiton brossé (Or 23cts)	33 826 875-28
	Noir mat	33 826 875-33
	Champagne (Or 22cts)	33 826 875-47
	Chrome brossé	33 826 875-93
	Dark Platinum brossé	33 826 875-99

Accessoires requis



**Douchette extractible -
Champagne brossé (Or 22cts)**

27 721 970-46

33 826 875



Diagramme de débit



Certificats

LGA_18901.

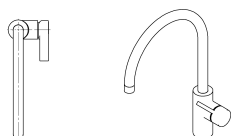
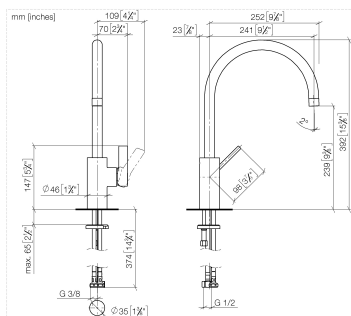
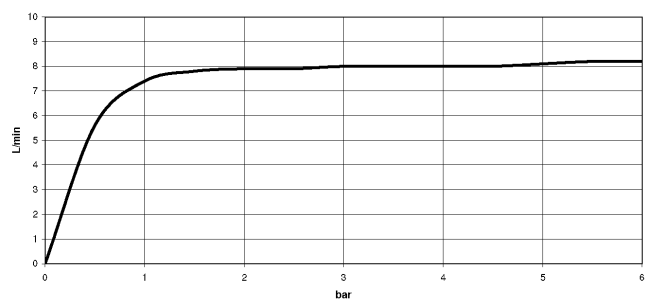
33 826 875

Les pièces pour les
autres finitions
peuvent être
trouvées ici : Chrome

